

Type No. 380-011-011



MEGA-Line
RACING ELECTRONIC GmbH
Haunersdorfer Str.3
D - 93342 Saal a.d. Donau

Germany

Phone: +49 (0) 9441 6866 - 0
Fax: +49 (0) 9441 6866 - 11

Mail: info@mega-line.com
Web: www.mega-line.com

Description / features

The valve block is supplied with pressured air from the Central Unit AGS, which controls the two valves inside according to the actual shift situation. Each pressure channel is equipped with a pressure sensor. The signal can be analysed in the Central Unit AGS. An internal sensor supplies information about the current temperature. A data memory stores unit specific information.

Technical specifications

Electronic data:

Operating voltage	13.5V nom.
Operating current (electronic)	approx. 50mA
Operating current (per activated valve)	approx. 330mA

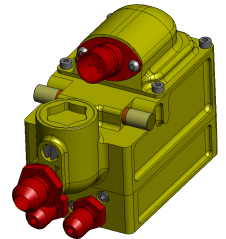

Mechanical data:

Dimensions L x W x H	approx. 78.2 x 58 x 78.6 mm
Weight	approx. 510 g
Fitting for air pressure inlet	Dash6
Fitting for air pressure up	Dash4
Fitting for air pressure down	Dash4

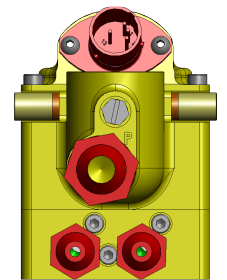

Pneumatic data:

Max. operating pressure	6 - 8 bar
-------------------------	-----------

Connector:

Deutsch 13 pin	AS010-35PN
----------------	------------

Temperature range:

Ambient (min/max)	0 .. +120°C
-------------------	-------------

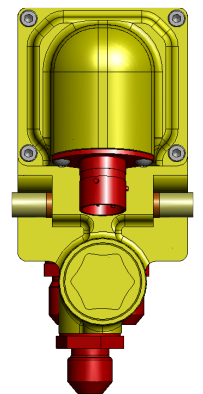

Ordering information:

Article no.	380-011-011
Order no.	6724

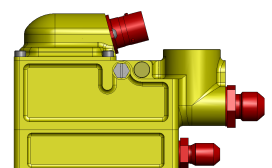

Type No. 380-011-011

MEGA-Line
RACING ELECTRONIC GmbH
Haunersdorfer Str.3
D - 93342 Saal a.d. Donau

Germany

Phone: +49 (0) 9441 6866 - 0
Fax: +49 (0) 9441 6866 - 11

Mail: info@mega-line.com
Web: www.mega-line.com

Pin assignment (electric)

Pin	Function	Dia [AWG]	Type
1	+12V electronic	22	PWR
2	GND electronic	22	PWR
3	valve UP	22	digital in
4	valve DOWN	22	digital in
5	NC		
6	NC		
7	ID data	26	data
8	NC		
9	NC		
10	GND sensor	22	PWR
11	T valve block	26	analog out
12	pressure UP	26	analog out
13	pressure DOWN	26	analog out

Port description (pneumatic)

Port	Function	Dimension	max.torque [Ncm]
1	Air pressure inlet	Dash6	1200
2	Air pressure DOWN	Dash4	1000
3	Air pressure UP	Dash4	1000

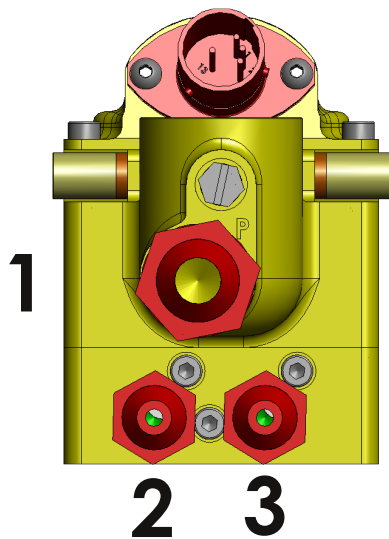

EXTERNAL VALVE BLOCK

Type No. 380-011-011



MEGA-Line
RACING ELECTRONIC GmbH
Haunersdorfer Str.3
D - 93342 Saal a.d. Donau

Germany

Phone: +49 (0) 9441 6866 - 0
Fax: +49 (0) 9441 6866 - 11

Mail: info@mega-line.com
Web: www.mega-line.com

Assembly dimensions

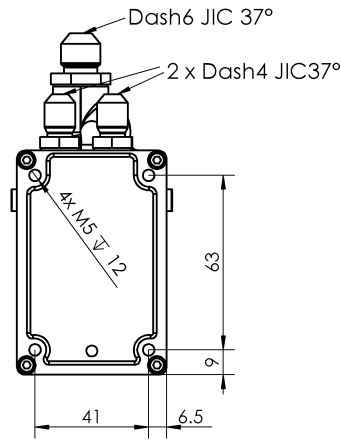

380-011-011
bottom view

Mechanical dimensions

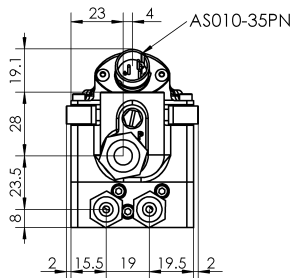

380-011-011
front view

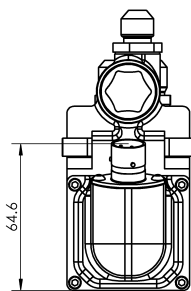

380-011-011
top view

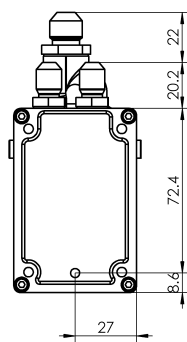

380-011-011
bottom view

Attention!

This area must not be covered in any way.
Area needs unrestricted exposure to ambient pressure!

